



1001

Wheel Dumpers



The All-Round Dumper 1001.

Fast, safe and easy transport even on the roughest of terrain and a discharge height of up to 1.56 m... the four-wheel dumper 1001 is particularly versatile, agile and extremely robust.

- High-tipping skip (1.56 m dumping height); maximum payload 1000 kg.
- Compact dimensions, optional narrow tires (990 mm machine width).
- Hydrostatic twin-lock four-wheel drive; continuously variable speed up to 114 km/h max.
- Large service and maintenance access.
- Clearly laid out instrument panel and wide, robust leg protection.



Technical specifications

Operating data

Payload	1,000 kg
Net weight	1,261 kg
Skip capacity level	415 l
Skip capacity heaped	525 l

Engine / Motor

Engine / Motor manufacturer	Yanmar
Engine / Motor type	3TNV76
Engine / Motor	Diesel
Engine performance acc. to ISO 3046/1	17 kW
Displacement	1,116 cm ³
Travel speed	16 km/h
Articulation angle	33 °
Pendulum angle	15 °
Turning radius	3,200 mm
Gradeability	45 %
L x W x H	3,080 x 1,180 x 2,580 mm



Dimensions

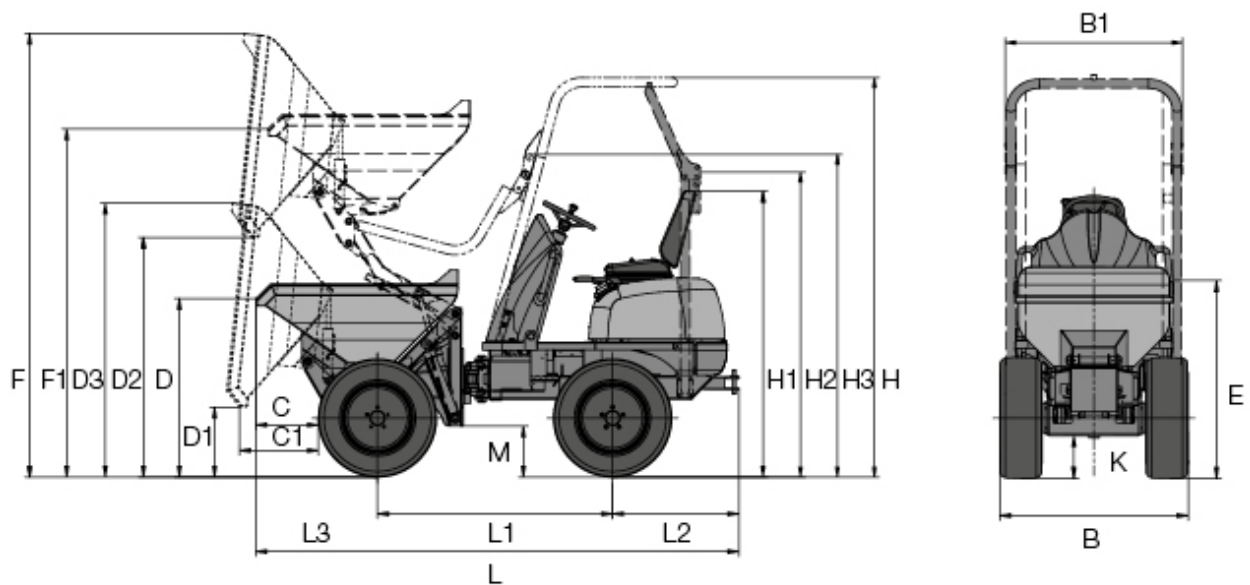

Please note

that product availability can vary from country to country. It is possible that information / products may not be available in your country. More detailed information on engine power can be found in the operator's manual; the stated power may vary due to specific operating conditions.

Subject to alterations and errors excepted. Applicable also to illustrations.

Copyright © 2015 Wacker Neuson SE.